

Warnings

CAUTION—risk of fire and this product must be installed in accordance with the applicable installation code by a person familiar with the construction and operation of the product and the hazards involved.

Suitable for wet locations.

Mounting orientation must have light source facing down.

Electrical service must be disconnected during installation.

Proper grounding is required to protect against shock and proper operation.

Fasteners Provided

- (2) 3/8"-16 x 1" stainless steel bolts
- (2) 3/8" stainless steel washers

Tools Required

- 9/16" wrench or socket for 3/8" mounting bolts
- Wiring tools and connectors

Single Fixture Mounting

Step 1: Ensure drill pattern on pole matches drill pattern in Diagram A.

Step 2: Route SJEOOW wire whip from fixture through 1.25" hole in pole.

Step 3: Fasten (2) 3/8"-16 bolt with lock washer as shown in Diagram B. Torque bolts to 20lb-ft.

Step 4: Connect 5 conductor wire to 5 wire whip from fixture as shown in Diagram C. If 0-10V dimming is not required, terminate ends from wire whip.

Step 5: Install pole top cap.

Diagram A

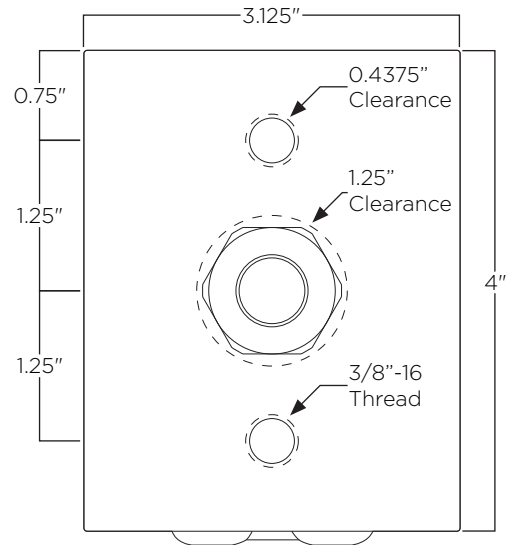

Diagram B

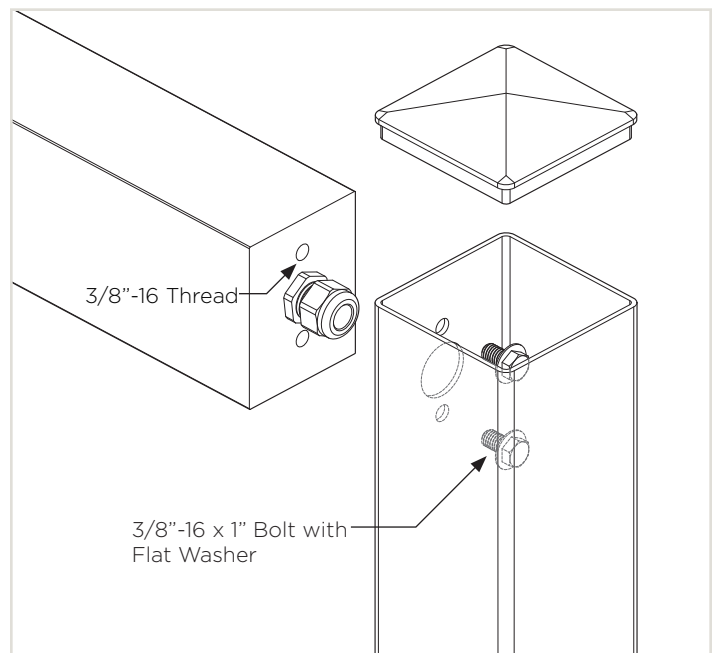

Diagram C

